



# PRODUCT CATALOG

Professional Sliding Rollers &  
Hardware Manufacturer

[sliding-roller.com](http://sliding-roller.com)

# PRODUCT/SLIDING ROLLERS



**R groove**



**H groove**



**Y groove**

## Plastic Coated Bearing Roller



**V groove**



**U groove**



**F groove**

### Bearing Material

- Chrome Steel
- High Carbon Steel
- Bearing Steel
- Stainless Steel
- ...

### Core Feature

- Low noise
- Long life-time use
- Smooth sliding
- High load capacity & stable structure
- Wear-resistant, durable & rust-proof
- Easy installation
- Stable & consistent running speed

### Plastic Material

- POM
- PA/PA6/PA66 (Nylon)
- POK/PU
- ...

### Quality Guaranteed

- Premium bearings, uniform hardness, long service life
- New plastic material, no recycled materials
- Precision machining, stable operation, low noise
- Strict pre-shipment inspection, consistent performance
- Precision injection & machining control

### Customization (OEM&ODM)

- Groove depth
- Groove Width
- Chapter
- Color
- Brand
- ...

### Application

- Sliding Windows & Doors
- Furniture hardware
- Conveyor systems
- Automatic Machine
- Medical Equipment
- ...

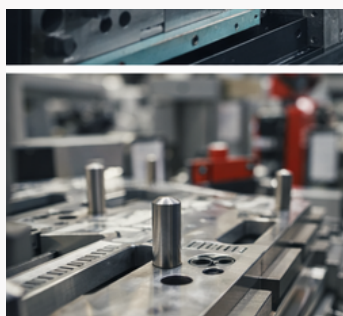

# *sliding roller*



DOUBLE I-BEAM TRACK  
SLIDING ROLLERS



NON-STANDARD  
BEARING WITH PLASTIC



SCREW SLIDING  
ROLLER



D22 DRAWER ROLLER



3D PRINTER DOUBLE  
BEARING ROLLER



CUSTOM SPECIAL-  
SHAPED ROLLERS



DEEP GROOVE  
BEARING

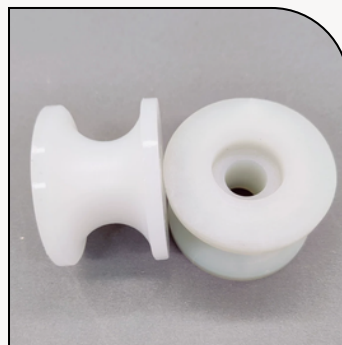

PLASTIC ROLLER

## ABS Door Nylon Sliding Roller Adj Hardware



608zz U-groove Rollers  
 ABS and Nylon Material  
 Carbon Steel Bearing/Bearing Steel Bearing  
 Color: Customized  
 Sturdy, Durable, Smooth Sliding  
 Used in doors, windows, furniture, and sports equipment.

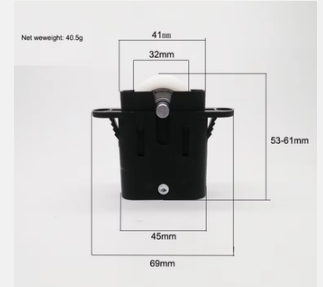

## Aluminum nylon sliding rollers for UPVC Window

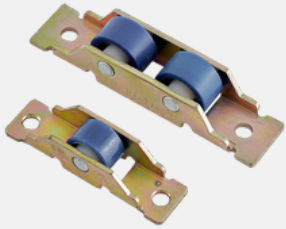

F groove/U groove/V groove  
 Size can be customized  
 aluminum, plastic, zinc alloy

## Aluminum Frame Sliding Door Fittings Roller



Upper Roller and Screw 608zz Bearing Iron + Nylon  
 Closet moving door, Living room sliding door...  
 Color can be customized.

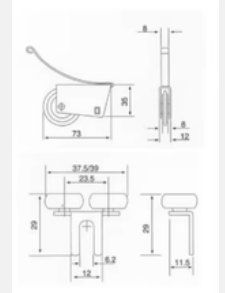

## Aluminum Fittings Adjustable Sliding Window Rollers Accessories

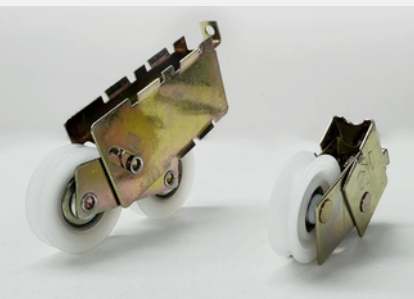

608zz Carbon steel/Bearing steel Bearing/Iron cover bearing  
 Zinc plated/Stainless steel  
 60-80KG  
 Colored zinc  
 Single/Double Rollers

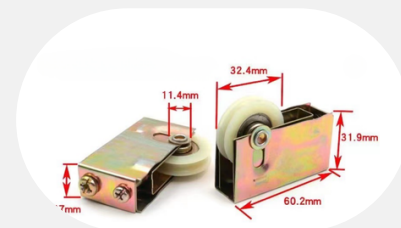
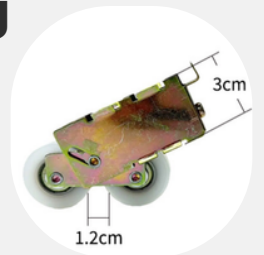



## Aluminum Alloy Sliding Rollers

V groove/U groove  
20.5\*5mm/22\*9mm  
Aluminum profile doors and windows

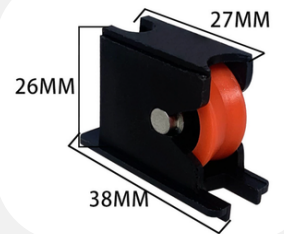

## Hanging Nylon Wheel Four Wheel Sliding Gate Roller

zinc alloy/nylon  
23mm  
0-60kg  
wooden door, shower door

## Upvc Aluminum Plastic Window Adjustable Roller

Singler roller/double rolles  
21\*20\*135mm/Customized  
V groove/U groove/F groove  
plastic+iron/stainless steel/carbon steel bearing  
door/window/furniture  
15kg/100kg

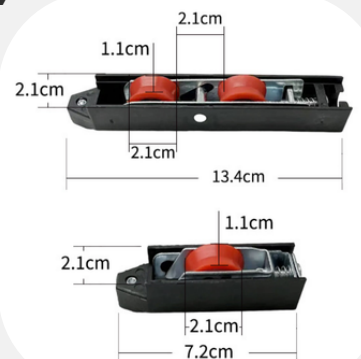

## Broken Bridge 60/70 Slidning Roller Accessories Hardware

Single roller/Double rollers  
Galvanized or chrome plated/stainless steel  
UPVC windows or doors  
V groove/U groove/F groove  
Width 24-28mm/24-30mm  
60-100kg

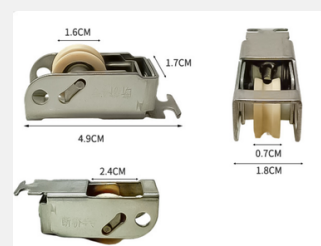
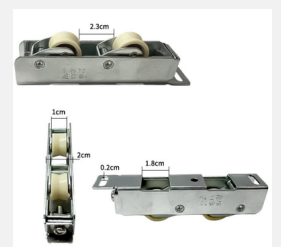

# PRODUCT/STAINLESS STEEL HARDWARE

## Heavy-Duty Long Strip Door & Window Rollers

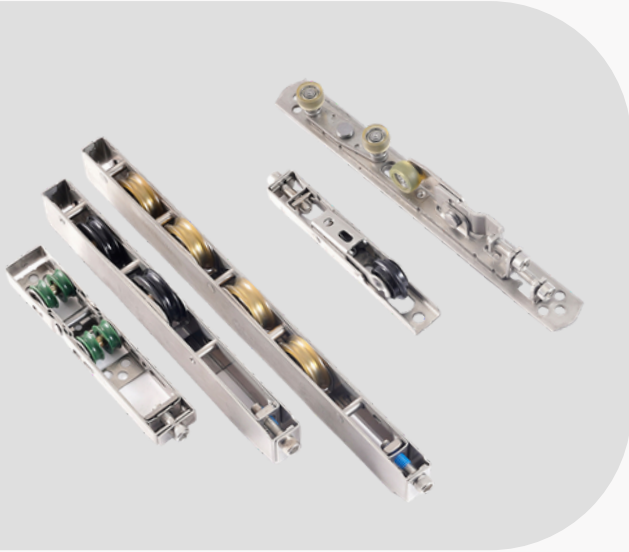

### Housing

SS201/SS304

### Sliding Rollers

POK/PPSU/Brass/SS402

### Bearing

608zz/6200 Series

### Parts

Screw/Circlip/Nut

Engineered for heavy-duty sliding doors, curtain walls, and industrial doors, providing unparalleled load capacity and stability for smooth operation.



**POK Nylon Roller**



**PPSU Roller**



**Brass Roller**



**402 Stainless steel Roller**

## 201/304 STAINLESS STEEL HOUSING

Ultra-Silent Operation Equipped with Kevlar fiber silent layer & PA self-lubricating wheel set, noise level  $\leq 25\text{dB}$  for smooth, jam-free sliding



### Strong Load-Bearing

Capacity Handles heavy doors/windows, suitable for residential, commercial & industrial

Ultra-Long Service Life 100,000+ push-pull tests (National Standard Grade A), 3-5x higher wear resistance, 15+ year lifespan



### ANTI FALL PART

Built-in anti-fall structure withstands high pressure, protects rollers from damage and crushing, and effectively prevents derailing for stable, long-lasting operation.



### CUSTOMIZEABLE WHEEL WHEEL MATERIAL & COLOR

We support customization of wheel materials (including POK, nylon, copper, stainless steel, etc.) and colors to perfectly match your door/window system design and project needs. OEM/ODM supported.



# HEAVY DUTY SLIDING ROLLERS

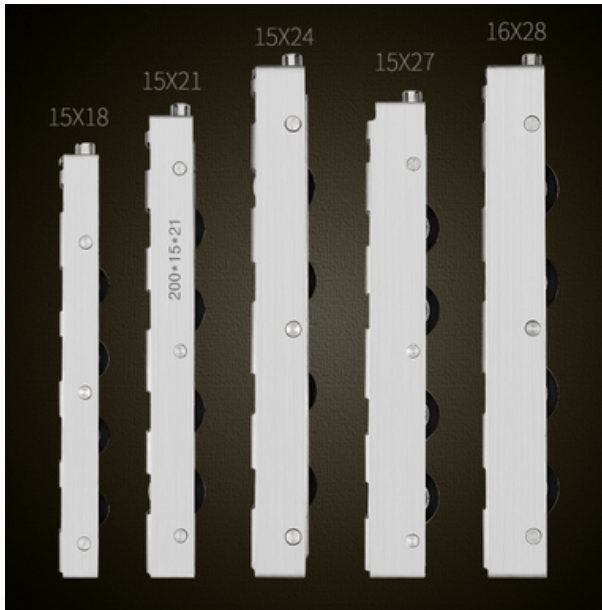

Size	Size
15x13	15x17
15x21	15x24
15x24	15x27/16x27

Custom sizes available upon request.

OEM/ODM supported.

Length is non-critical for functionality

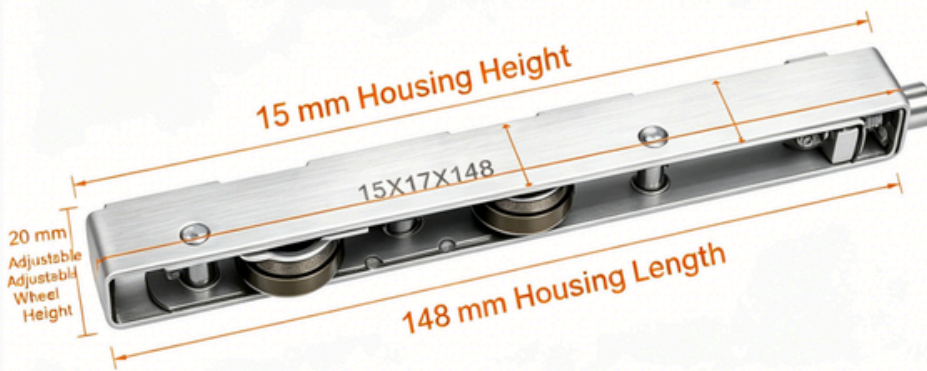

Product Series	Wheel Configuration	Optional Wheel Material	Total Length (mm)	Wheel Diameter (mm)	Fit Groove (mm)	Load Capacity/Set (kg)	Housing Material	Core Features
Light-Duty Home Series	2 Wheels (Single Row)	POK/Nylon/Brass/SS420	140-160	R11-R13	16-20	40-60	SS201/SS304	Silent, Smooth, Easy Installation
Standard Engineering Series	4 Wheels (Single Row)	POK/Nylon/Brass/SS420	180-225	R12-R15	16-24	80-120	SS201/SS304	High Load-Bearing, Anti-Derailment
Heavy-Duty Villa Series	4 Wheels (Double Row)	POK/Nylon/Brass/SS420	155-180	R12-R13	20-24	120-150	SS201/SS304	Super Load-Bearing, Impact Resistance
Super Heavy-Duty Commercial	6 Wheels (Single Row)	POK/Nylon/Brass/SS420	206-240	R12-R15	20-24	150-200	SS201/SS304	High Wear Resistance, Long Service Life
Extreme Load Series	8 Wheels (Single/Double Row)	POK/Nylon/Brass/SS420	206-260	R12-R15	20-24	200-260	SS201/SS304	Extreme Load-Bearing, Anti-Fall Design



# *other products*

## *catalogue*



INJECTION MOLDED PARTS



RUBBER O-RINGS



PLASTIC PARTS



DOOR ROLLER



BALANCE SHAFT

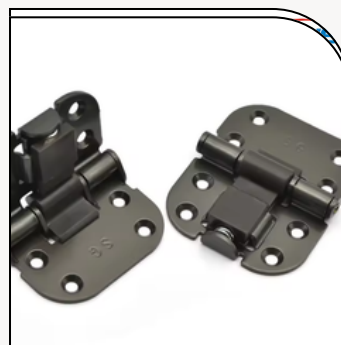

WINDOW HINGE

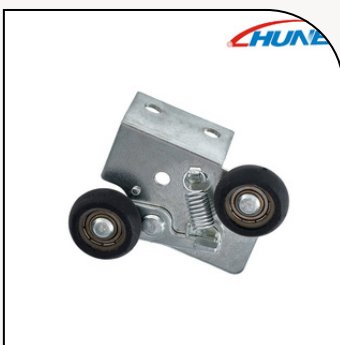

ROLLERS HARDWARE

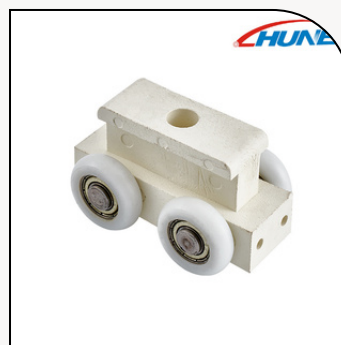

CUSTOMIZED ROLLERS

# Manufacturing Equipment

## Injection Molding Equipment

We are equipped with a full set of professional injection molding machines ranging from 60T to 400T clamping force, supporting the production of various plastic parts, hardware accessories, pulleys, and customized components.



## Professional Drawing Customization

We provide custom sample production according to your drawings or requirements, supporting flexible material selection, dimension adjustment and structure optimization. All samples are made with the same production process as mass production to ensure consistent quality. We offer sample photos, parameter verification and fast lead times for your pre-order testing.



## Factory Production Capacity

We specialize in the manufacturing of hardware and door & window accessories, supported by standardized production and strict quality control. We provide efficient, reliable one-stop production solutions to meet diverse customer needs.



## Quality Control

All-electric machines ensuring weight and dimensional accuracy. Every product is manufactured with professional machinery, ensuring stable dimensions, excellent concentricity and consistent quality. High-precision machining brings smoother operation, lower noise and longer service life, fully satisfying high-standard hardware demands.



## Production Process



1. Raw material procurement



2. Precision machining

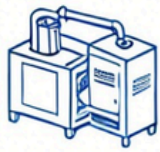

3. Heat treatment



4. Cleaning and rust prevention

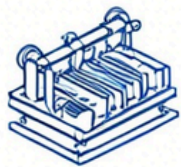

5. Overmoulding

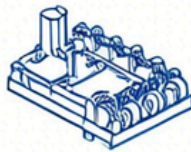

6. Assembly

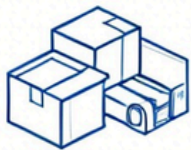

7. Testing and packaging



8. Shipment

## Customization Process

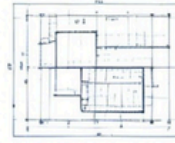

1. Confirm drawings or samples



2. Confirm product quantity and specifications



3. Quotation



4. Place order



5. Confirm mold



6. Sample confirmation



Terevolobites confirmation



7. Mass production

## Why Choose Us



1. Free samples (samples freight borne by client)



2. Samples within 3-7 days



4. Mass production  
20-30 days



5. One-stop Procurement & Customization Services



6. 7\*24H customer service service give a quick respond

## Who We Are



Headquartered in Zhejiang, China, our factory was founded in 1999

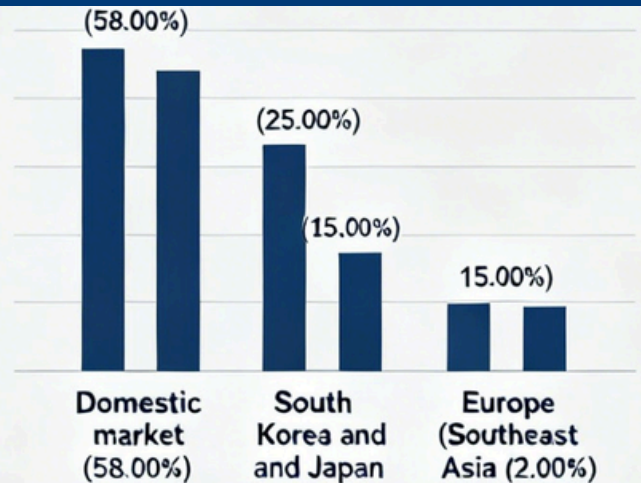

## How We Guarantee Quality

Samples are always produced before mass production

Final inspection is always carried out before shipment



## What Can You Buy From Us?

Window&door rollers and hardware, furniture rollers, metal stamping parts, plastic coated roller and plastic rollers

## Can we print our own logo on the products?

Yes, OEM & ODM services are supported, including logo printing and packaging customization



## What Services Can We Provide?

We offer free sample evaluation upon request

Customization based on your drawings or samples is accepted

We keep a large range of sizes in stock for immediate delivery, with low MOQ to support your needs



## How long is the delivery time?

Spot goods will be shipped to the port within 2 days after payment is received  
For production orders, goods will be delivered within 7 working days

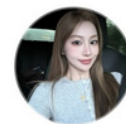

**ShirleyYing**

SalesManager  
Zhejiang Hune Micro Bearing Co.,Ltd

**Address: No. 118,  
Fazhan Road, Wengyang  
Industrial Zone, Yueqing  
City, 1st Wenzhou City,  
Zhejiang Province**



**Website:  
hunepulley.com**



**Email:  
shirley@cnhune.com/  
/hune@cnhune.com**



**WhatsApp  
+8615058997617**



**Wechat:  
18157305562  
(hunesale)**

# Thanks.

Thanks for your interest in our company. We will look forward to establishing good business relationship with you in the near future.